

# RIFTEK

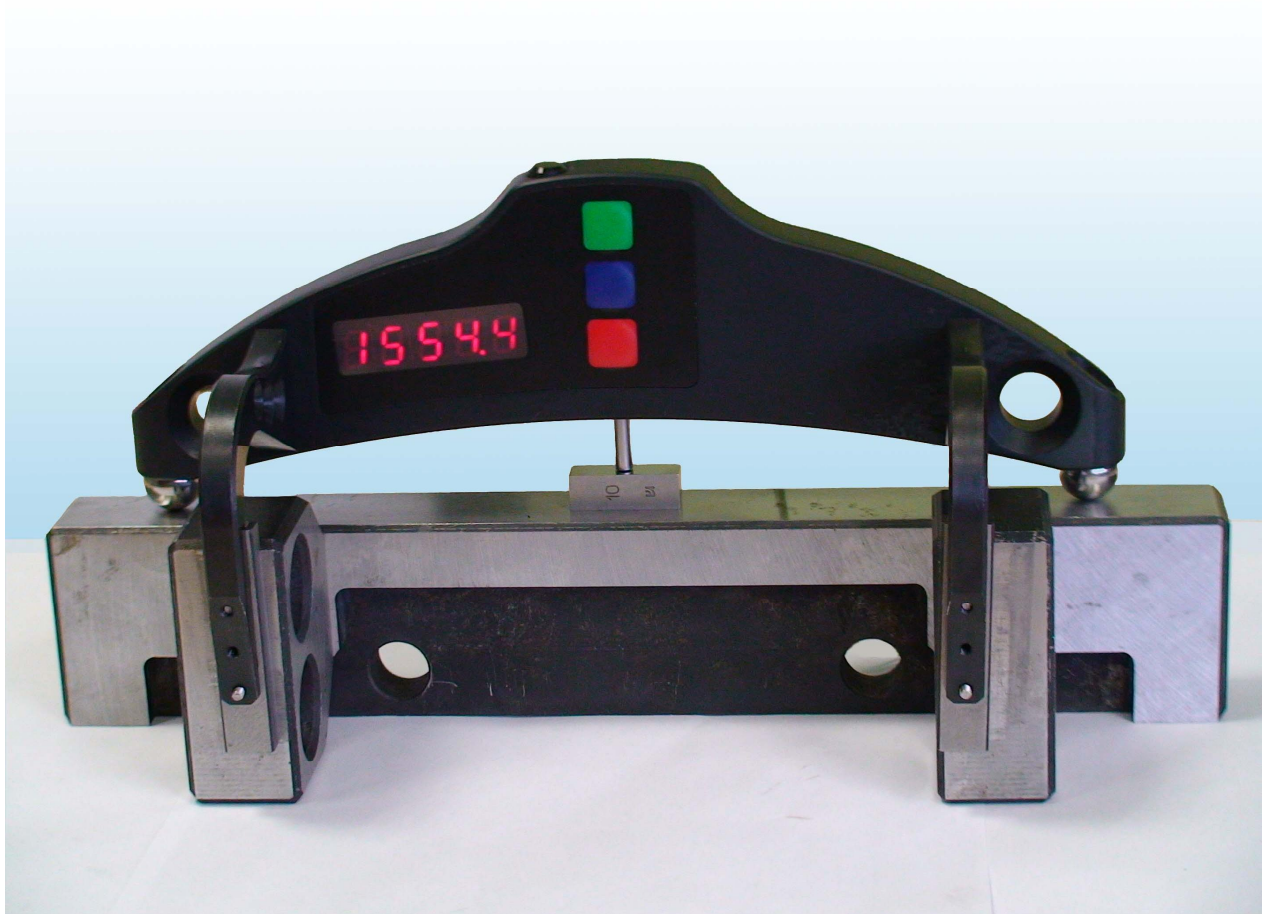

---

## Wheel Diameter Measuring Gauge IDK-BT

### User's manual.

#### RIFTEK

Logoisky tract 22  
Minsk, Republic of Belarus,

Tel/fax: +375172813513

E-Mail: [info@riftek.com](mailto:info@riftek.com)

Internet: [www.riftek.com](http://www.riftek.com)

Certified according to ISO 9001:2008

## Contents

1.	Safety precautions and measurement conditions.....	3
2.	Electromagnetic compatibility .....	3
3.	General information.....	3
4.	Basic data and performance characteristics .....	3
5.	Example of item designation when ordering .....	4
6.	Complete set to be supplied .....	4
7.	Design. ....	5
7.1.	Electronic gauge .....	5
7.2.	Indication device (option) .....	5
8.	Operation principle.....	6
9.	Working with the gauge and working in autonomous regime.....	6
9.1.	Gauge turn-on. ....	6
9.2.	Single measurement.....	6
9.3.	Measurement with averaging.....	7
9.4.	Gauge turn-out .....	8
10.	Indication parameters setup .....	8
10.1.	Bluetooth ON/OFF .....	8
10.2.	Image rotation.....	8
10.3.	Image brightness set-up. ....	9
10.4.	Millimeters-Inches display set-up .....	10
11.	Service operation modes.....	10
11.1.	Calibration conditions.....	10
11.2.	Get into operational modes.....	10
11.3.	Calibration of the sensor zero .....	11
11.4.	Calibration of the device base.....	12
12.	Working with the gauge and PDA.....	12
12.1.	Operation principle.....	12
12.2.	Gauge and PDA activation.....	13
12.2.1.	Gauge turn-on .....	13
12.2.2.	PDA turn-on .....	13
12.3.	On-line measurement .....	13
12.4.	Measurements with database maintenance.....	14
12.5.	Browsing the database .....	16
12.6.	Saving database on flash memory card .....	16
13.	PDA program setting.....	17
13.1.	Selection of measurement units .....	17
13.2.	Data and Time settings .....	17
13.3.	Tolerances settings.....	18
13.4.	Database selection .....	19
13.5.	Selection and formation of measurement scheme .....	19
13.5.1.	Selection or removal of the measurement scheme.....	19
13.5.2.	Formation of a new measurement scheme .....	20
13.5.3.	Loading of a new measurement scheme.....	20
13.6.	New electronic gauge connection.....	20
13.7.	Selection and changing of language and terminology.....	21
13.7.1.	Preparation and installation of language support file .....	21
13.8.	PDA software version viewing.....	21
13.9.	Deactivation.....	22
14.	Working with the gauge and PC .....	22
14.1.	Program starting .....	22
14.2.	IDK-PC connection .....	22
14.3.	Measurement .....	23
15.	Database maintenance software .....	23
16.	Charging of built-in accumulator battery .....	24
17.	Warranty policy .....	24
18.	Annex 1. Procedure of installation of Bluetooth connection between IDK and PC.....	24
	Distributors.....	27

## 1. Safety precautions and measurement conditions

- The metering accuracy depends greatly on the wheel surface quality. Therefore it is necessary to carry out the check and presorting of the wheel surface roughness and flaws before measuring the diameter.
- Prior to place the gauge onto the wheel there is a need to clean the wheel parts that contact with gauge ball bearings, side supports and measuring tip, of the mud.
- At arranging the gauge, do not allow hitting its supports on the wheel and any measuring tip side hitting
- At arranging the gauge, do not apply strong forcing in the direction of the measuring tip movement. It can result in the gauge sag, that will bring about the uncertain metering result
- It is necessary to inspect the gauge supports periodically and to cleanse them
- To save the battery power the display extinguishes if there were no buttons pressings for 60 seconds, at that only blinking dot is shown. Pressing any button just turns on the display and does not act in any other way in this case.

## 2. Electromagnetic compatibility

The gauge has been developed for use in industry and meets the requirements of the following standards:

- EN 55022:2006 Information Technology Equipment. Radio disturbance characteristics. Limits and methods of measurement.
- EN 61000-6-2:2005 Electromagnetic compatibility (EMC). Generic standards. Immunity for industrial environments.
- EN 61326-1:2006 Electrical Equipment for Measurement, Control, and Laboratory Use. EMC Requirements. General requirements.

## 3. General information

Electronic gauge is designed for measuring wheel rolling circle diameter (amount of wear) of railway, metro and tram in the course of checkup, examination, repair and formation of wheel sets. Measurements are made directly on rolling stock without wheel set roll-out.

## 4. Basic data and performance characteristics

Name of parameter	Value
Measurement range, mm	600...1300 or on request
Measurement error, mm	±0.2
Indication discreteness	0.1mm, 0.01mm * or 0.01 inch **
Position of measurement, S, mm	on request
Distance between axes of ball bearings (base), mm and measurement range, mm	200±0.5 (600...850 mm) or 250±0.5 (750...1260 mm) or 300±0.5 (950...1300 mm)
Display	build-in, LED
Operating temperature, °C	-5...+40
Power supply – built-in rechargeable battery	two AAA 1,2V
The number of measurements that can be taken before battery recharge is not less than	1000
Weigh, kg	0,5

## 5. Example of item designation when ordering

### IDK-S/B-MIN/MAX-X-BT

Symbol	Description
S	Position of measurement, mm
B	Base, mm
MIN	Bottom of measuring range, mm
MAX	Up of measuring range, mm
X	Position of indication. A – Indication is at the side of side supports (figure A), B – Indication is at opposite side (figure B)
BT	Bluetooth presence*

\* The gauge with Bluetooth can work in autonomous regime and together with RF303 PDA or PC, with measurements saving in database.

**Example:** IDK-70/250-850/1260-A-BT. Position of measurement – 70 mm; base of the gauge – 250 mm; bottom of measuring range – 850 mm; up of measuring range – 1260 mm; position of indication – A, BT – Bluetooth presence .

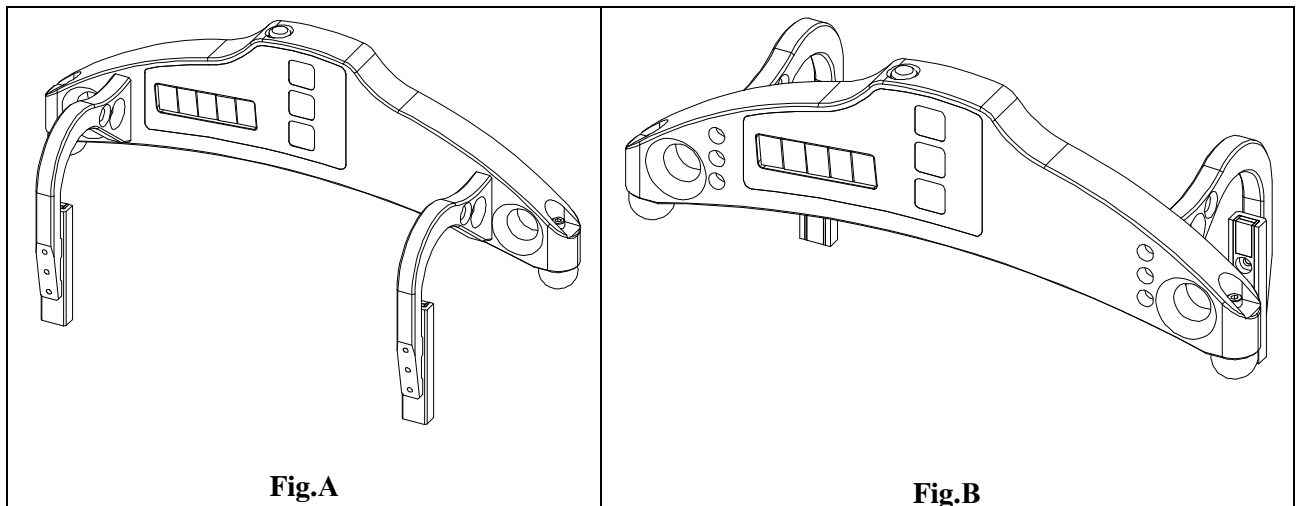

## 6. Complete set to be supplied

Name	Quantity	Weight, kg
Wheel diameter measuring gauge IDK series	1 piece	0,5
Charger	1 piece	0,2
RF303 – PDA (option)	1 piece	0,4
Charging device 5V 3.0A for PDA (option)		
Manual	1 piece	
Case	1 piece	
Database management system (CD)		
<b>Calibration tools (option)</b>	<b>on request</b>	
Flat block RF510.11.000 (fig.4)	-	
Reference wheel block for calibrating RF510.11.850 (fig.5)	-	

5

## 7. Design.

### 7.1. Electronic gauge

Electronic gauge contains two ball supports to place the gauge onto the roll surface, two side magnet supports to base the gauge to the wheel edge and a measuring tip.

There are a digital numeric display and control buttons on the front panel of the gauge. “Charge” connector for charging device connection and Bluetooth indication LED are situated on the top panel of the gauge.

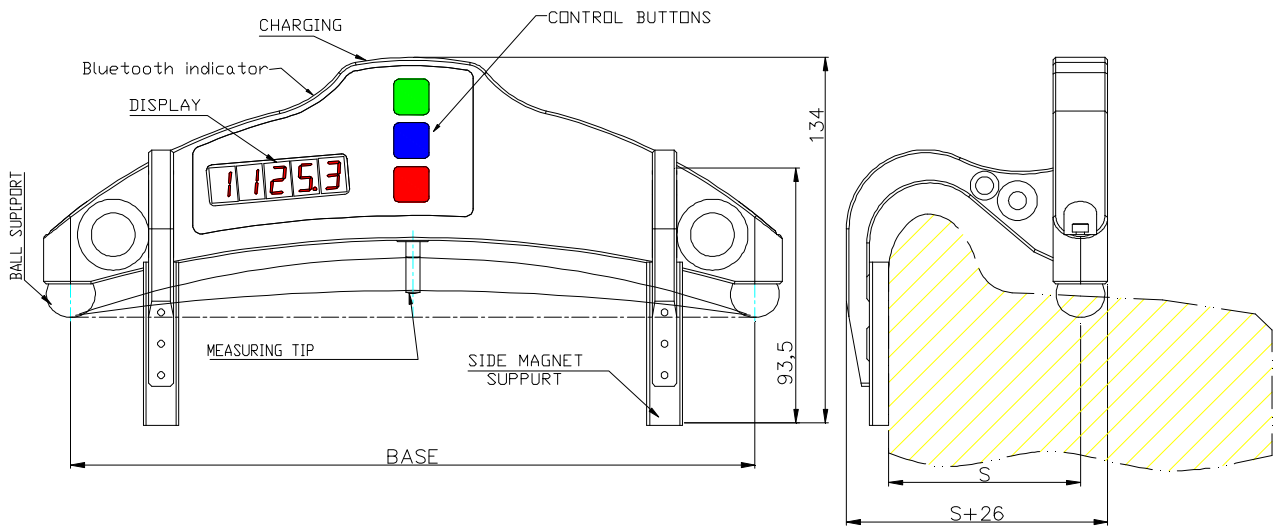

Figure 1

### 7.2. Indication device (option)

PDA is designed for control of the gauge, data reception from the gauge, indication of measurement results, parameters input and data storage.



Figure 2

Fig. 2 indicates:

- (1) Turn-on button
- (2) Activation indicator (green LED), charge indicator (red LED)
- (3) Universal connector (connection of flash memory card, connection to PC USB-port or charging device)
- (4) Loud speaker
- (5) Stylus

Overall dimensions of PDA are shown in figure 3.

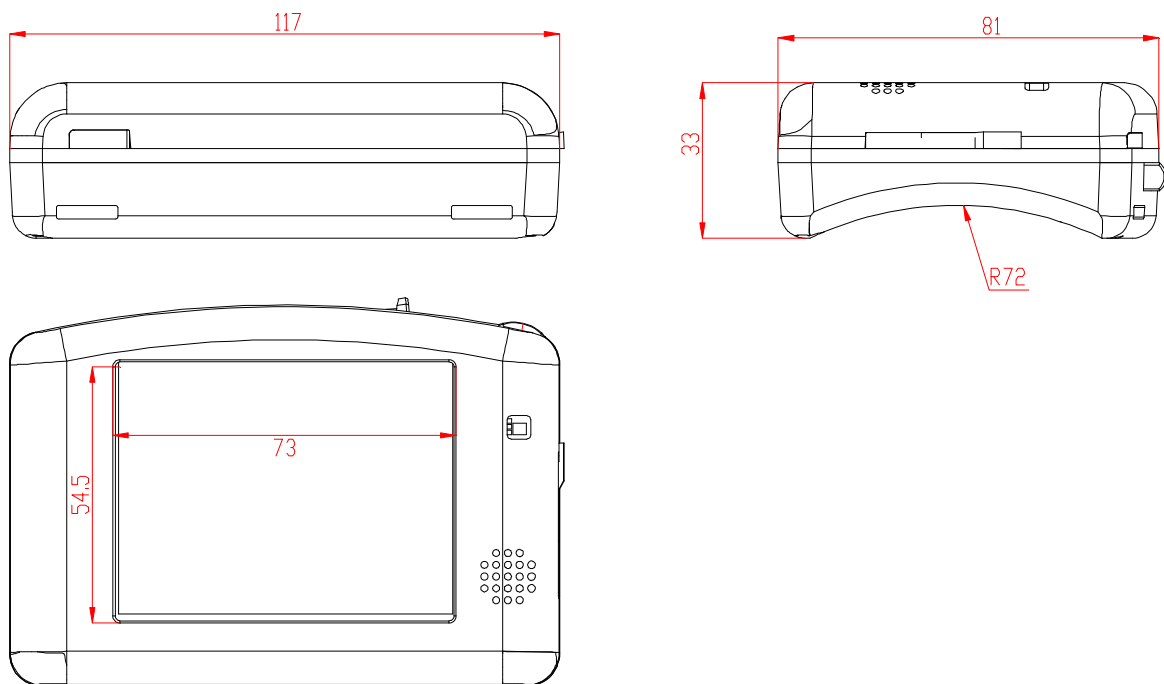

Figure 3

## 8. Operation principle

The measurement of the diameter is performed according to the “three points” technique, without the complete wheel coverage. The measurement method is based on the diameter calculation by the known length of the segment chord (the distance between the ball bearings centers), which is obtained at placing the gauge onto the wheel. The saggita of the segment is measured by means of the displacement converter.

## 9. Working with the gauge and working in autonomous regime

### 9.1. Gauge turn-on.

Press **Red** button to turn on the power. The display shows “ErrP” message if the accumulator battery voltage became lower then the control level. In this case the short-term work is possible after pressing any key.

### 9.2. Single measurement.

To perform measurement, it is necessary to:

- turn the power on (press **Red** button). The display shows “- - - -”;

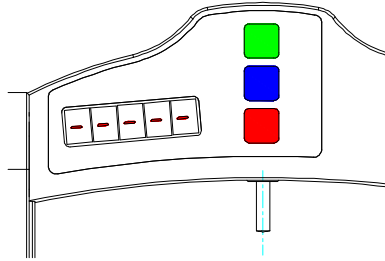

- place the gauge onto the wheel;
- make sure the ball supports are tight against the roll surface and side supports are adjacent to the edge of the wheel;
- press **Green** button.
- in a 1 second the display will show the value of the wheel diameter.

For viewing the result of measurement with indication discreteness of **0.01mm** (it is accessible only in a mode of direct indication) it is necessary to press **Blue** button, thus displayed result will be shifted to the left on one digit. Next pressing **Blue** button will lead to return of indication to a starting position:

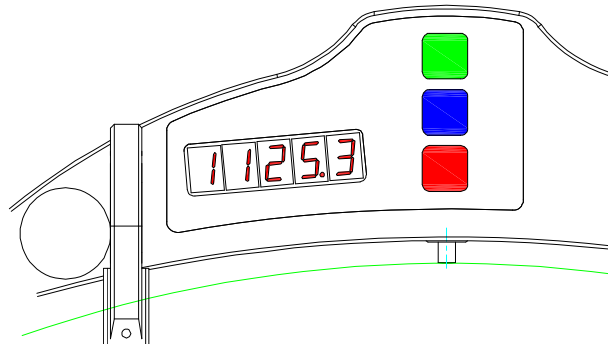

### 9.3. Measurement with averaging

The program of the wheel diameter calculation contains an averaging algorithm that allows eliminating the surface defects influence on the diameter measuring result. All the results of metering, performed after the **Red** button pressing, are averaged. The measurement is meant to be **Green** button pressing.

To carry out measurements it is necessary to

- turn the power on (press **Red** button). The display shows “- - - -”;
- place the gauge onto the wheel
- make sure the ball supports are tight against the roll surface and side supports are adjacent to the edge of the wheel;
- press **Green** button;
- display shows the value of pressing counter “n x”, where **x** – quantity of averaged values;
- in a 1 second display shows an average value over the set of metering (over the quantity of **Green** button pressings)
- move the gauge to a new position and repeat the measuring.  
(The total quantity of measurements averaged in this way can run up to 9999.)
- Press **Red** button to reset averaging result at switching to another wheel.

For viewing the result of measurement with indication discreteness **0.01mm** (it is accessible only in a mode of direct indication) it is necessary to press **Blue** button, thus displayed result will be shifted to the left on one digit. Next pressing **Blue** button will lead to return of indication to a starting position.

## 9.4. Gauge turn-out

The gauge turn-out occurs automatically. The display extinguishes if there were no buttons pressings for 60 seconds, at that only blinking dot is shown. If there were no button pressings for 4 more minutes, the gauge is turned out completely. You can turn the gauge off by long pressing **Red** button (more then 3 sec.).

## 10. Indication parameters setup

### 10.1. Bluetooth ON/OFF

To switch Bluetooth ON it is necessary to:

- turn the power on
- press **Blue** button and keep it pressed for more than three seconds
- display will show “**bt On**”
- to turn Bluetooth off press **Green** button. Display will show “**bt OF**”

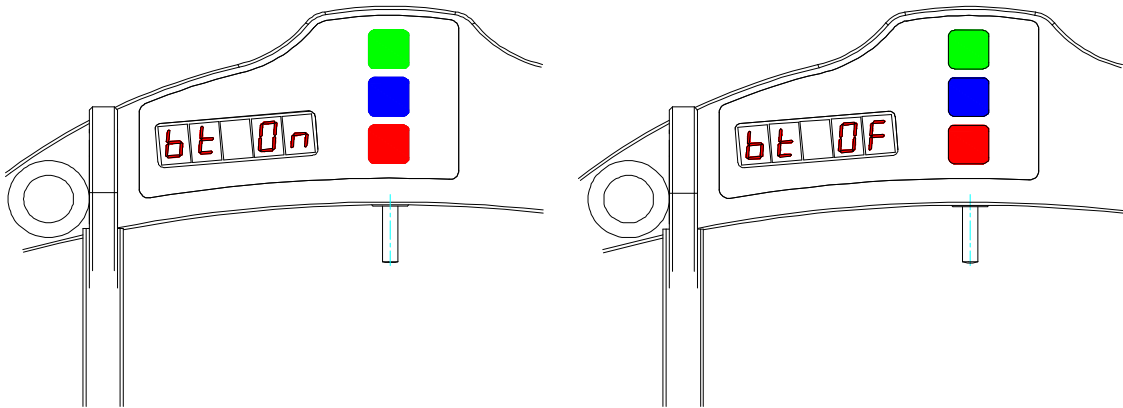

- to save the changed parameters press **Red** button. The display shows “**SAUE**” message, press the **Green** button to confirm saving and **Red** button to cancel saving of the changed parameters

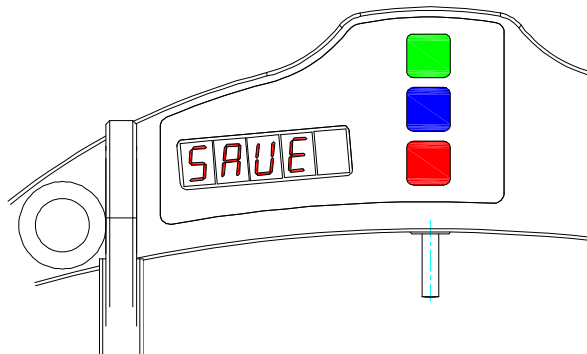

### 10.2. Image rotation

To rotate the image it is necessary to:

- turn the power on (press **Red** button);

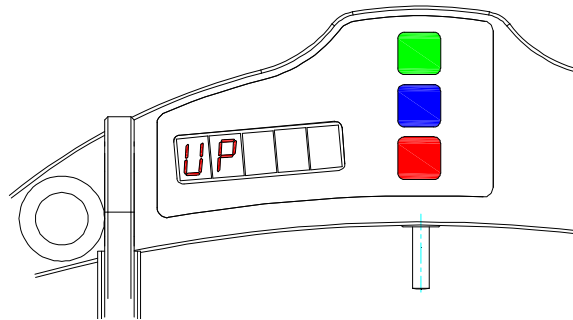

- press **Blue** button and keep it pressed for more than three seconds;
- display will show "bt On" or " bt OF";
- press **Blue** button again. Display will show "Up"

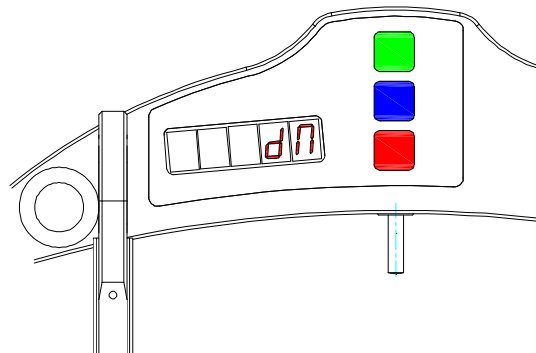

- by the pressing of **Green** button turn over the image: the message "Up" will be turned over 180°;
- to save the changed parameters press **Red** button. The display shows "SAUE" message, press the **Green** button to confirm saving and **Red** to cancel saving of the changed parameters;

Image rotation function allows observing the result in the way comfortable for the operator regardless of the gauge placement direction.

#### Notes:

- indication discreteness of **0.01mm** is accessible only in a mode of direct indication;
- the separation point is indicated at the top side of the screen in the reverse indication regime.

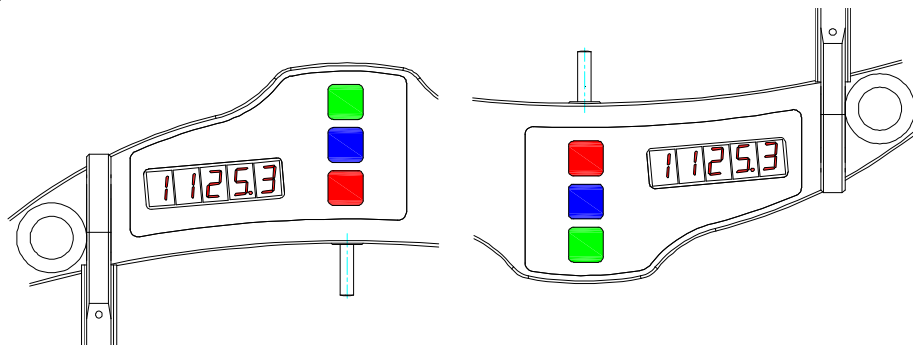

### 10.3. Image brightness set-up.

To change the display brightness it is necessary to:

- turn the power on (press **Red** button).;
- press **Blue** button and keep it pressed for more than three seconds;
- display will show "bt On" or " bt OF";

- press **Blue** button again until “**brt X**” message appears on the display;

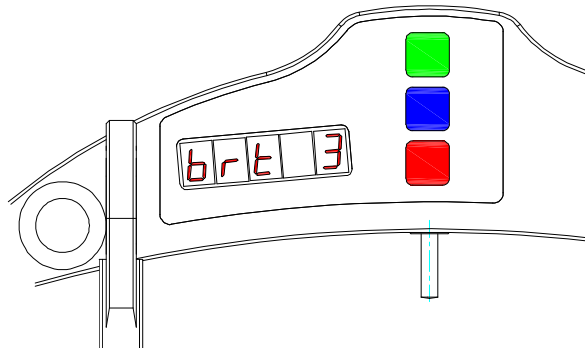

- choose the necessary brightness value by **Green** button pressings;
- to save the changed parameters press **Red** button the display shows “**SAUE**” message, press the **Green** button to confirm saving and **Red** to cancel saving of the changed parameters;

At brightness choosing one should take into account that increased brightness enhances power consumption and decreases the period till battery recharge moment.

#### 10.4. Millimeters-Inches display set-up

To change the mode it is necessary to:

- turn the power on (press **Red** button).;
- press **Blue** button and keep it pressed for more than three seconds;
- display will show “**bt On**” or “**bt OF**”;
- press **Blue** button again until the either “**SI**” or “**Inch**” message appears on the display. “**SI**” – measuring results will be shown in mm, “**Inch**” – measuring results will be shown in inches;
- choose the necessary value by **Green** button pressings;
- to save the changed parameters press **Red** button the display shows “**SAUE**” message, press the **Green** button to confirm saving and **Red** to cancel saving of the changed parameters

## 11. Service operation modes

This section contains the description of the modes for the check of device efficiency and calibration. As erroneous actions in this mode can lead to invalid measurement results, only specially trained personnel should perform such operations.

### 11.1. Calibration conditions

**Calibration of the device is not necessary in the current work. It is necessary only after producing, repairing and also after checking with negative result.**

To perform calibration the following means are necessary:

- Calibration plate with the deviation from flatness less then  $\pm 0,5$   $\mu\text{m}$  for 250 mm length (or Flat block RF510.11.000, figure 4);
- Johansson gauge;
- reference wheel of the known diameter (or Reference wheel block RF510.11.850, figure 5)

### 11.2. Get into operational modes

- To get into the operational modes it is necessary to turn-off the device (press **Red** button more then 3 seconds).

- Keeping **Green** button in pushed position turn-on the device (press **Red** button).
- Display shows “**CLbr.0**” message (the mode of calibration of the sensor's "0").
- To get into this mode it is necessary to press **Green** button (see. p. [11.3](#)).
- For transition to next mode it is necessary to press **Blue** button.
- Display shows “**CLbr.b**” message (the mode of device base calibration).
- To get into this mode press **Green** button (see. p. [11.4](#)).
- To get out the mode of calibration press **Red** button.

### 11.3. Calibration of the sensor zero

- When zero calibration mode being enabled, the display shows the Johansson gauge value used for calibration in increments of 0.5  $\mu\text{m}$ .
- If editing of the Johansson gauge value is not required, go to the next step. To edit the Johansson gauge value, press the **Blue** button, and the digit to be edited starts blinking. Changing over between the digits is made by pressing the **Blue** button while changing of values is made by pressing the **Green** button. When editing is finished, press the **Red** button and confirm or cancel saving of the parameter by pressing the **Green** button or **Red** button, respectively.
- Press the **Green** button, and the Johansson gauge value starts blinking, which means that the device must be placed onto a flat plate and a Johansson gauge with nominal value of the previous step must be placed under the measuring tip. The Johansson gauge must be tightly fitted to the flat plate and supports and balls of the device must be firmly forced against the plate.
- Press the **Green** button, and the display shows current reading of the sensor in its own coordinate system. By moving the device, assure that repeatability of measurement results is obtained.

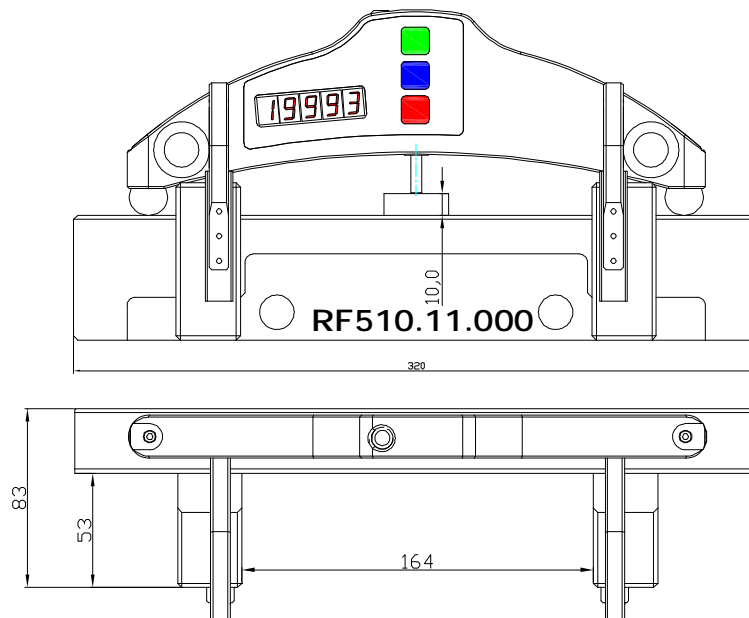

Figure 4

- If readings of the sensor are sufficiently stable, press the **Blue** button. Sensor zero position is calculated in the device coordinate system, and prompt appears to save calibration results. Press the **Green** or **Red** button to confirm or cancel saving of the results, respectively.

## 11.4. Calibration of the device base

- Device base calibration mode being enabled, the display shows the value of reference diameter used for calibration.
- If editing of the diameter value is not required, go to the next step. To edit the diameter value, press the **Blue** button, and the digit to be edited starts blinking. Changing over between the digits is made by pressing the **Blue** button while changing of values is made by pressing the **Green** button. When editing is finished, press the **Red** button and confirm or cancel saving of the parameter by pressing the **Green** button or **Red** button, respectively.
- Press the **Green** button, and the reference diameter value starts blinking, which means that the device must be placed onto a gage with the diameter value set at the previous step. The device supports must be firmly forced against the reference block.
- Press the **Green** button, and the display shows current reading of the sensor in the device coordinate system. By moving the device, assure that repeatability of measurement results is obtained.
- If readings of the instrument are sufficiently stable, press the **Blue** button. Device base value is calculated, and prompt appears to save calibration results. Press the **Green** or **Red** button to confirm or cancel saving of the results, respectively.

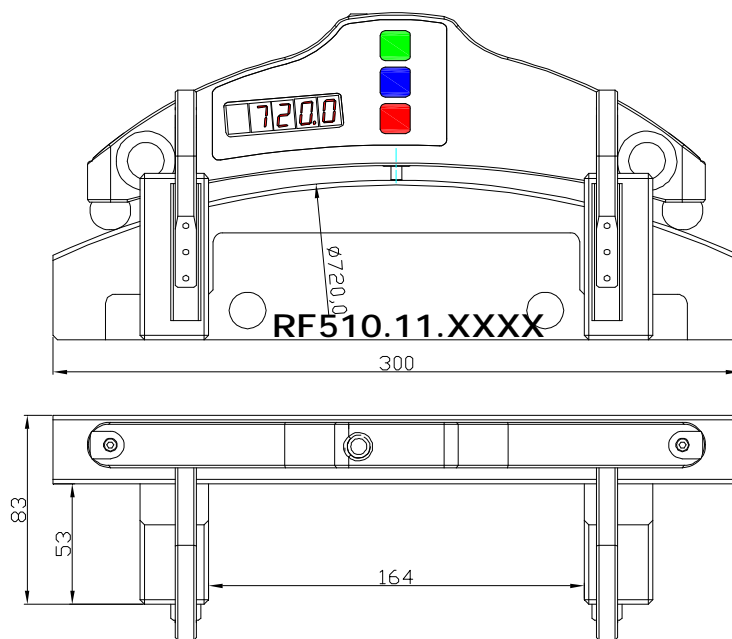

Figure 5

**NOTE:** Video-help for calibration procedure you can find here [www.riftek.com/resource/video/idk\\_calibr.avi](http://www.riftek.com/resource/video/idk_calibr.avi)

## 12. Working with the gauge and PDA

### 12.1. Operation principle

Operator mounts the gauge onto the wheel to be measured. Having received a command from PDA, the gauge performs the measurement of the wheel diameter. Measurement result is displayed on PDA, can be saved in the PDA memory, and transferred to the PC database. Simultaneously, additional parameters can be saved: operator

number, side identifier (left or right wheel), axis number, locomotive (carriage) number, wheel pair number, etc.

## 12.2. Gauge and PDA activation

### 12.2.1. Gauge turn-on

Press **Red** button to turn on the power. The display shows “**ErrP**” message if the accumulator battery voltage became lower than the control level. In this case the short-term work is possible after pressing any key.

### 12.2.2. PDA turn-on

Turn the PDA on by pressing the button (1), Fig. 2. Activation indication (2) will show a green LED lit.

After the PDA is switched on, some time will pass until automatic wireless communication is set between the gauge and the PDA, which is accompanied by blinking of a blue LED (1) on the diameter gauge. The LED goes out when the link is established.

The PDA screen will show the main program window containing: main menu; indicators of PDA charging degree; indicator of Bluetooth connection showing serial number of the gauge with which connection is established and the **Measurement** button.

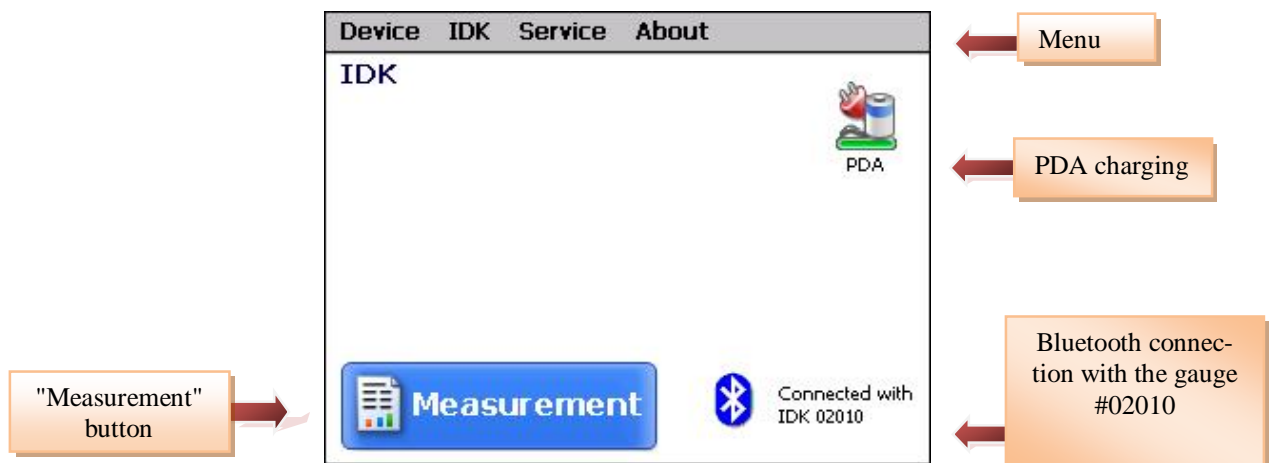

## 12.3. On-line measurement

To take measurements:

- turn-on the gauge, the display shows — “- - - - -”;
- turn-on PDA;
- press **Measurement** button on the screen of PDA; PDA is activated in measurement regime and display shows:

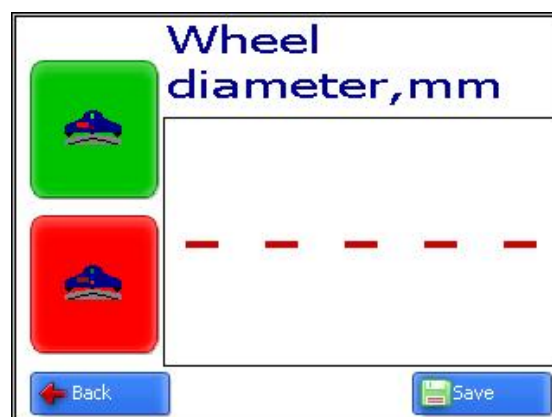

- place the gauge onto the wheel;
- make sure the ball supports are tight against the roll surface and side supports are adjacent to the edge of the wheel;
- press **Green** button. (**Note:** hereinafter, the button, marked by green or red color is a corresponding button on the gauge or PDA screen). In a 1 second the displays of the gauge and PDA will show the value of the wheel diameter. When the diameter goes beyond set limits its value is highlighted with red color:



#### Buttons:



- diameter measurement



- averaging reset

to continue the measurement with averaging:

- press **Green** button;
- display shows the value of pressing counter “n x”, where x – quantity of averaged values;
- in a 1 second display shows an average value over the set of metering (over the quantity of **Green** button pressings)
- move the gauge to a new position and repeat the measuring. (The total quantity of measurements averaged in this way can run up to 9999.)
- Press **Red** button to reset averaging result at switching to another wheel.

#### 12.4. Measurements with database maintenance

A fully functional work with the gauge involves maintenance of the measurements database.

To take measurements:

- select in the main menu **Profilometer > Measurement**, the window of parameters input will appear

Enter parameters wheel pair

Date: 23/04/09 Worker: 6709

Wheel pair: 1 Run: 276000

Series: series 1 Side: L

Locomotive: 1200 Axle: 1

Save Cancel





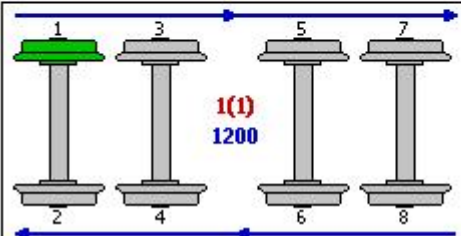



- If necessary, fill in/edit the required fields
- to save parameters, press the **Save** button, and the program will offer the selected measurement scheme (see par. 13.5.):

Date : 23/04/09  
 Series : series 1  
 Worker : 6709  
 Number : 1200  
 Axle : 1  
 Side : L  
 Wheel pair : 1  
 Run : 276000



Measure Exit

**Designations:**

- 1(1)** - order number of the car to be measured (number of cars in the train);
- 4580** - number of the car to be measured;
-  - editing of the input wheel parameters;
-   - a previous/subsequent wheel;
-  - a measured wheel;
-  - a wheel to be measured next time;
-  - a non-measured wheel;
-  - a measured wheel to be measured again
-  - measurement.

- Measure the wheel offered by the program (highlighted in green color), as it is shown in par. 12.3.

after the measurement, the PDA will show the value of diameter. When a diameter falls out of the specific tolerance, its value is indicated with red color

16



- when a satisfactory result is obtained, press **Save** on the display to save it
- the program will offer to pass to measurement of the next wheel in accordance with selected scheme of measurement

## 12.5. Browsing the database

To browse the database:

- select **Service > Profiles** in the main window. View on the screen

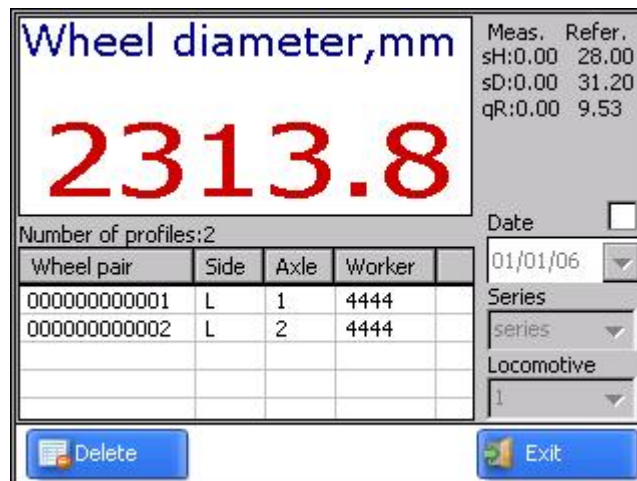

- for data filtering select data, series and number of locomotive

### Buttons:



– delete selected data

## 12.6. Saving database on flash memory card

One of the ways to transfer database from PDA to PC is to use flash memory card. To save database on the card, proceed as follows:

- connect cable **RF505.42** to the PDA universal connector
- insert flash card to the respective cable connector
- select **Device > Save to USB flash** in the main program window

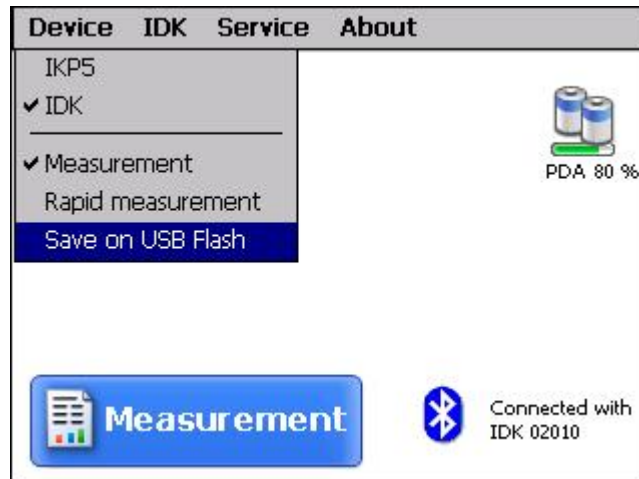

- if saving is successful, the screen will show **Data saved on USB Flash**
- remove flash card from the cable

## 13. PDA program setting

Prior to starting work with the gauge, PDA program setting must be performed.

### 13.1. Selection of measurement units

All parameters as well as measurement results can be presented in the metric system (millimeters) or in the English system of units (inches). To set measurement units, it is necessary to

- select **IDK >Units of measuring>[mm/inch]**

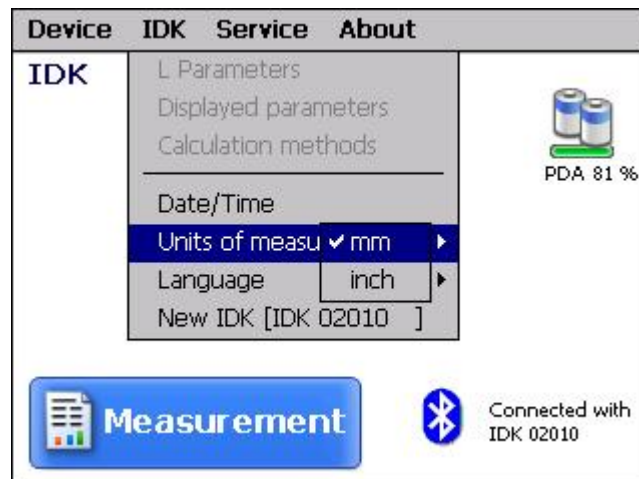

- select **mm** or **inch** option

### 13.2. Data and Time settings

To set data and time:

- select **IDK > Data/Time** in main window of the program. View on the PDA screen:

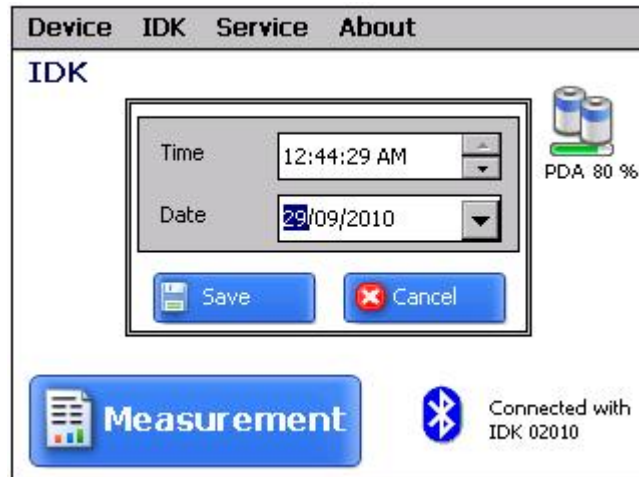

- write data and time
- press **Save**

### 13.3. Tolerances settings

The program automatically controls measured geometric parameters for going out beyond the tolerances set. It is possible for the user to create groups of tolerances. Control of parameters will be performed for a selected group. To set tolerances it is necessary to:

- select **Service > Tolerances** in the main window. View on the screen:

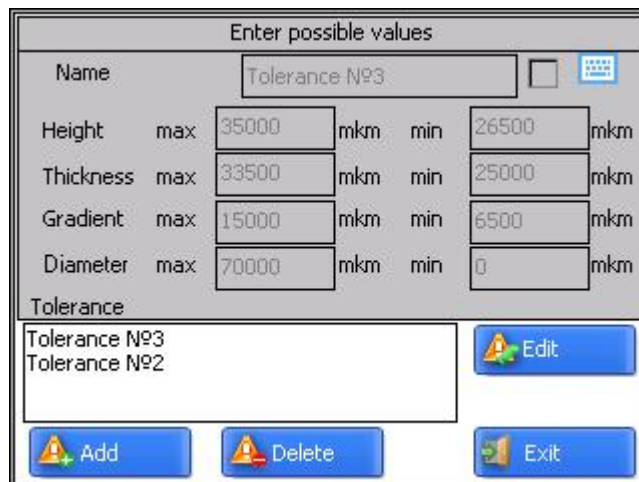

- adjust tolerances in the selected group or add a new group of tolerances and write corresponding values. All values are in micrometers.

#### Buttons:

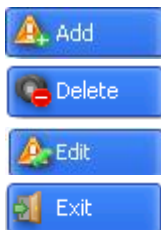

- add new group of tolerances;
- delete selected group of tolerances;
- edit selected tolerance;
- exit.

## 13.4. Database selection

If necessary, measurement results are saved in the PDA database. The program makes it possible to simultaneously create and store several database files connected with a concrete date of taking measurements. To select a database file,

- choose **Service > DB files** in the main window menu. The screen will show:

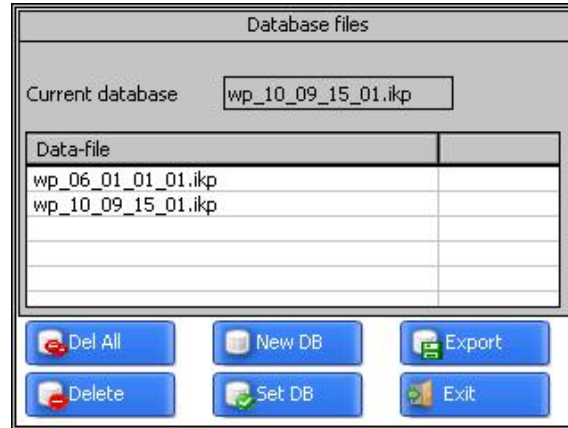

- To create a new database, press **New DB**. File with the name **wp\_yy\_mm\_dd.iqp** will be formed automatically, where **yy\_mm\_dd** is the current date;
- to select the available database, activate the line with the file name and press **Select DB**;
- to delete the selected file press **Delete**;
- to delete all files press **Delete all**;
- to save file in TXT form press нажать **Export**;
- to exit from the window press **Exit**

## 13.5. Selection and formation of measurement scheme

Measurement scheme is meant as a sequence of making measurements/processing of wheels in the rolling stock. The program automatically offers operator to perform measurement on a concrete wheel in accordance with selected scheme of wheel processing. The program contains several preset schemes. Besides, the user can form his own measurement scheme.

### 13.5.1. Selection or removal of the measurement scheme

To select a measurement scheme in the main window menu:

- select **Service > Schemes**. View on the screen:

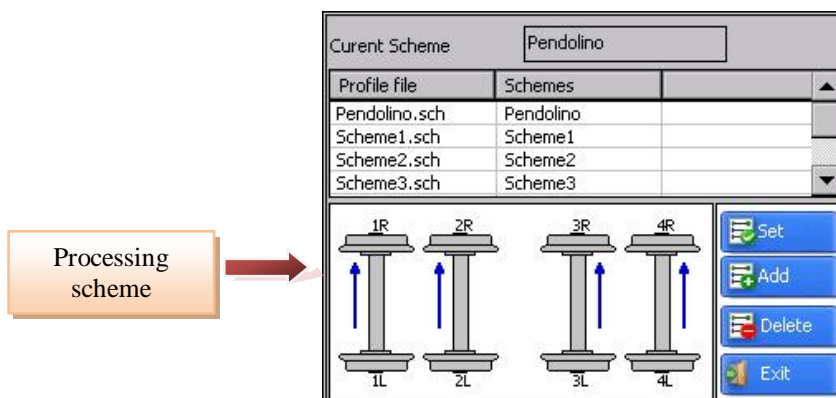

- by activating lines containing the scheme file name it is possible to look at available wheel processing schemes. Arrows in the figure show direction of processing of wheel sets as well as the names assigned to wheels (1L-first axis, left side; 2L-second axis, left side; 1R-first axis, right side, etc.);
- to set the selected scheme activate the respective line and press **Install**;
- to remove a scheme activate the respective line and press **Remove**.

### 13.5.2. Formation of a new measurement scheme

To form a new measurement scheme, press **Add**. The screen will show:

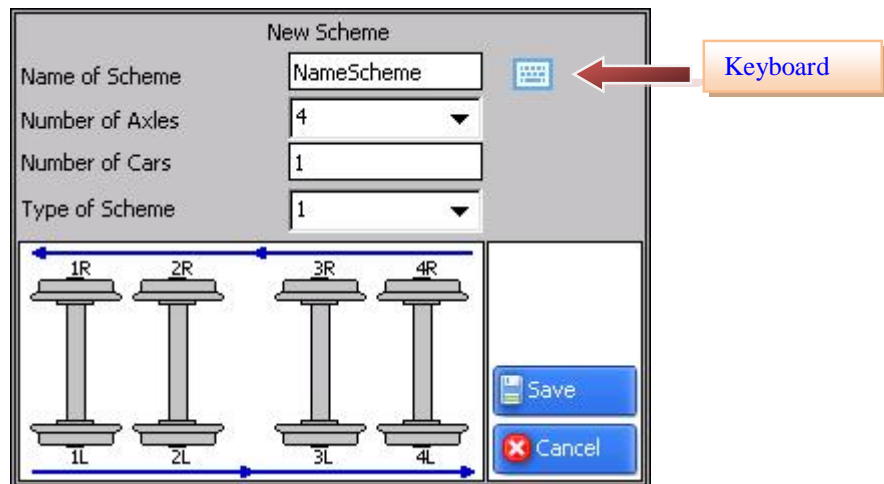

- by using on-screen keyboard type the scheme name;
- select the number of axles;
- select the number of coaches in the rolling stock (train);
- select the wheel processing scheme out of the options suggested press **Save**

### 13.5.3. Loading of a new measurement scheme

If you can not form a new scheme in accordance with par. [13.5.2](#), it is possible to use a special program for PC and then load the scheme to the PDA as it is shown in par. [15](#).

## 13.6. New electronic gauge connection

Bluetooth-connection of PDA is adjusted for work with the electronic gauge supplied with PDA complete package. To connect other scanning module it is necessary to:

- select **IDK > New IDK**

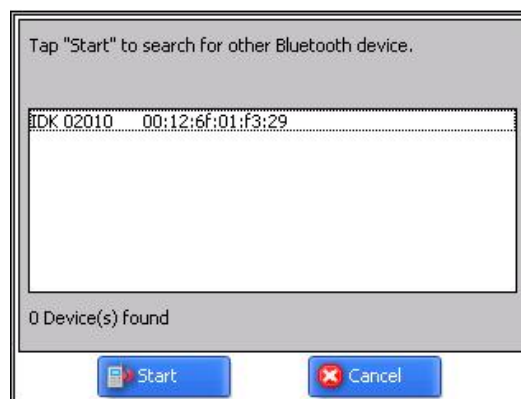

- press **Start** and wait for new devices (with serial numbers) will appear on the screen

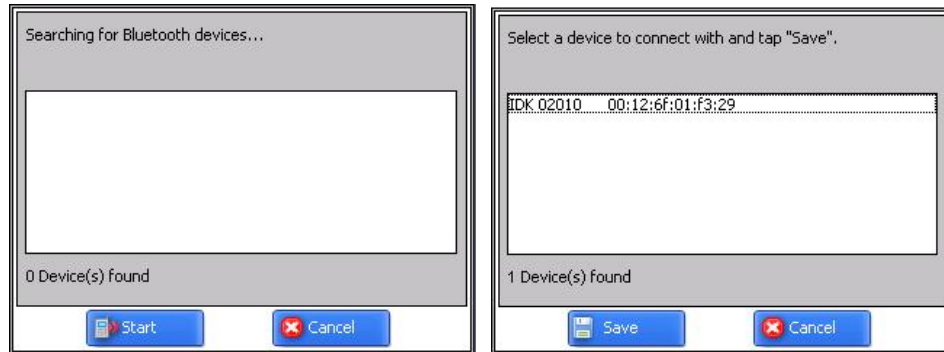

- select device and press **Save** to save new device address

### 13.7. Selection and changing of language and terminology

It is possible for the user to change the program language, form his own language support files as well as change/edit the terminology used.

To choose language in the main window menu select **IDK > Language**. Select the required language support file.

If no such file is available, it is necessary to use new files preparation procedure which is described in par. [13.7.1](#). and then load a new language file from PC to PDA as it is shown in par. [15](#).

#### 13.7.1. Preparation and installation of language support file

By default, working language of the program is English. Language support files are located in the directory used in the process of installation. By default the following directory is used: **C:\Program Files\RIFTEK\lcp5\_db\Language\**. The directory contains two files, **RUS.Ing** and **ENG.Ing**, to support Russian and English languages respectively.

To create support file for any other language, it is necessary to

- copy one of the existing files. For example, **ENG.Ing** under the other name, for example, **GER.Ing**
- edit the renamed files by using any text processor, namely, change all terms and phrases to analogous ones from the required language
- save the edited **\*.Ing** file in the **Language** folder
- to change and edit terminology, it is necessary to:
  - edit the corresponding language file by using any text processor;
  - save the edited **\*.Ing** file in the **Language** folder

### 13.8. PDA software version viewing

To look at the software version in the main window menu, select **About Program** tab. The screen will show:



## 13.9. Deactivation

To turn off the PDA, press power supply button and hold it down until the screen is blank.

## 14. Working with the gauge and PC

### 14.1. Program starting

To start the software, insert compact disk to PC CD drive and start **IDK.exe** file in the **Software** folder.

The main program window will appear:

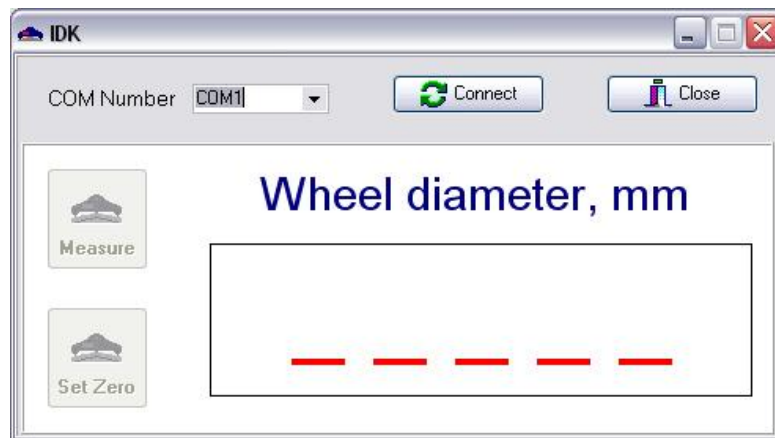

### 14.2. IDK-PC connection

- turn the gauge ON
- install connection between the gauge and PC as described in par. [18](#).
- select required port

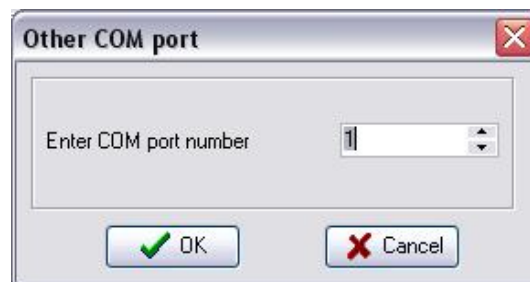

- press **Connect** for connection with the gauge
- If the connection is successful, the **Measurement** button in the main program window becomes active. You can begin to measure

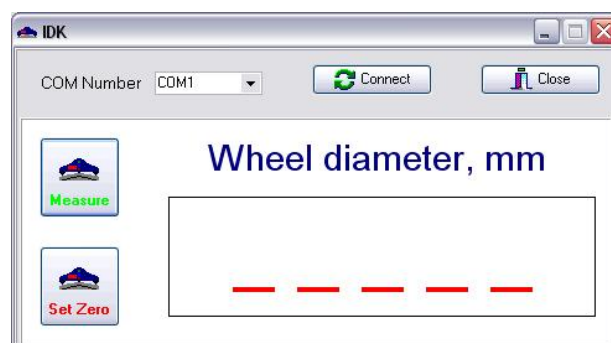



- diameter measurement;



- reset averaging result (on the screen “-----”);

### 14.3. Measurement

- place the gauge onto the wheel
- make sure the ball supports are tight against the roll surface and side supports are adjacent to the edge of the wheel;
- press **Measure** button; in a 1 second display shows result of measurement

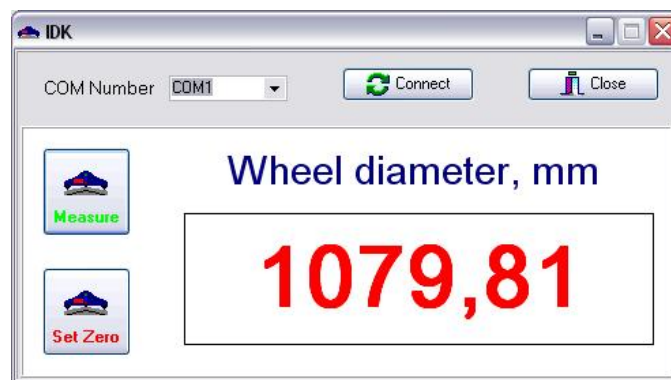

- to continue measurement with averaging press **Measure** button
- display shows the value of pressing counter “n x”, where x – quantity of averaged values;

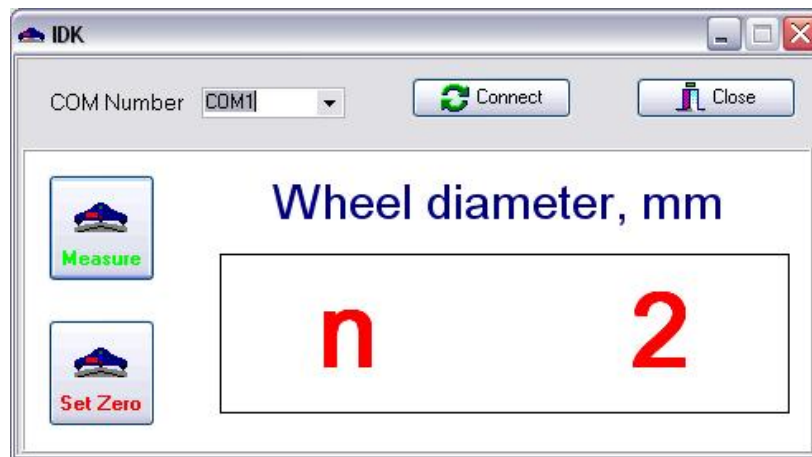

- in a 1 second display shows an average value over the set of metering (over the quantity of **Green** button pressings)
- move the gauge to a new position and repeat the measuring.
- Press **Red** button to reset averaging result at switching to another wheel.

## 15. Database maintenance software

The **ikp5\_DB** software is intended for maintaining wheel sets wear database on a personal computer (the updated version of the program can be downloaded from [www.riftek.com/resouce/files/ikp5.zip](http://www.riftek.com/resouce/files/ikp5.zip)).

User's manual - from this address:

[www.riftek.com/resource/download/ikpm\\_riftek\\_eng.pdf](http://www.riftek.com/resource/download/ikpm_riftek_eng.pdf).

## 16. Charging of built-in accumulator battery

To charge accumulator battery it is necessary to connect charging device to the power grid 85-250V and to a battery compartment on the top panel of the gauge.

The period of charging is 15 hours.

## 17. Warranty policy

Warranty assurance for the Wheel diameter gauge - 24 months from the date of putting in operation; warranty shelf-life - 12 months.

## 18. Annex 1. Procedure of installation of Bluetooth connection between IDK and PC.

To install Bluetooth-connection between the IDK and PC, it is necessary to:

- insert USB/Bluetooth-module to PC USB-port.
- continue installation of the equipment following instructions of the wizard by selecting successively:

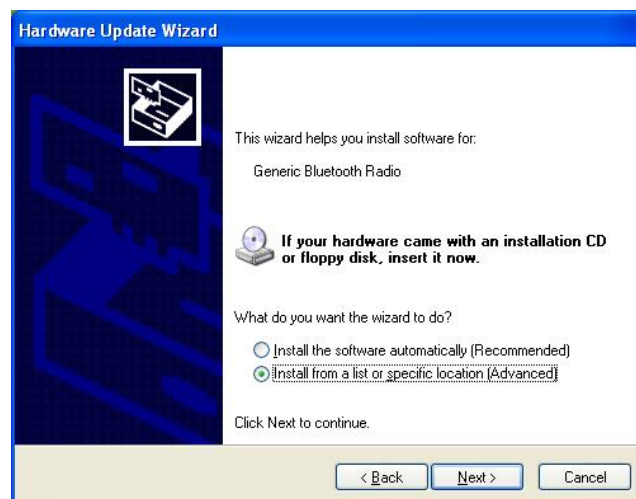

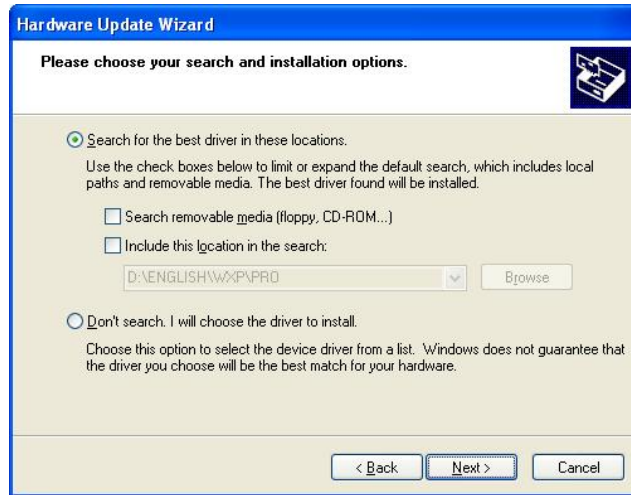

- when drivers are installed, the corresponding message and Bluetooth icon will appear in the screen:



- activate **IDK**.
- click right mouse key on the Bluetooth icon and select **Add Bluetooth device**



- Then Bluetooth installation wizard will start working:



- tick the **Device is installed and ready for connection**
- select **Next** for search

- when the search is completed, the wizard will show the devices found:



- select the required device (IDK), press **Next** and type access key (Pin). The key for each device consists of 4 symbols and is set based on the IDK serial number. For example, if the IDK number is 02010, then Pin=0200; 01309 - Pin=0139, etc.



- press **Next** and continue installation process.
- when required drivers are installed, the Bluetooth device will give a message with COM-port (outgoing) which should be opened for connection with IDK during measuring. In this case, the port is COM3:



## Distributors

27

<p><b>BENELUX.</b></p> <p><b>Feteris Components B.V.</b> Tel.: +31 (70) 3924421 Fax: +31 (70) 3644249 <a href="http://www.feteriscomponents.com">www.feteriscomponents.com</a> <a href="mailto:sales@feteriscomponents.nl">sales@feteriscomponents.nl</a></p>	<p><b>CHINA.</b></p> <p><b>Zhenshangyou Technologies Co.,Ltd.</b> Rm 2205-2210, Zhongyou Hotel 1110 Nanshan Road, Nanshan District 518054 Shenzhen, China Tel.: (86)755-26528100/8011/8012 Fax: (86)755-26528210/26435640 <a href="mailto:info@51sensors.com">info@51sensors.com</a> <a href="http://www.51sensors.com">www.51sensors.com</a></p>	<p><b>GERMANY.</b></p> <p><b>BIP-Industrietechnik GmbH</b> Am Elisabethhof 22, D-14772 Brandenburg D-41379 Brueggen, Germany Tel.: +49 (0) 33 81 - 75 90 -0 Fax: +49 (0) 33 81 - 75 90 -11 <a href="http://www.bip-industrietechnik.de">http://www.bip-industrietechnik.de</a> <a href="mailto:info@bip-industrie.de">info@bip-industrie.de</a></p>
<p><b>FUNLAND.</b></p> <p><b>Saalasty Oy</b> FIN -02920 ESPOO Tel.: +358 9 25115524 Fax: +358 9 25115510 <a href="http://www.saalasti.fi">www.saalasti.fi</a> <a href="mailto:jussi.puolakka@saalasti.fi">jussi.puolakka@saalasti.fi</a></p>	<p><b>INDONESIA.</b></p> <p><b>PT. Dhaya Baswara Saniyasa</b> Sentra Niaga Puri Indah Blok T6. 41 Kembangan, Jakarta 11610 Tel: 021 5830 4517 Fax : 021 5830 4518 <a href="mailto:management@ptdbs.co.id">management@ptdbs.co.id</a></p>	<p><b>ITALY.</b></p> <p><b>FAE s.r.l.</b> Via Tertulliano, 41 20137 Milano Tel.: +39-02-55187133 Fax: +39-02-55187399 <a href="mailto:fae@fae.it">fae@fae.it</a> <a href="http://www.fae.it">www.fae.it</a></p>
<p><b>LITHUANIA.</b></p> <p><b>JSC "Comexim"</b> Serbentu. 222, LT -5419 Siauliai Tel./Fax:+370 41553487 <a href="http://www.komeksimas.lt">http://www.komeksimas.lt</a> <a href="mailto:comexim@siauliai.aiva.lt">comexim@siauliai.aiva.lt</a></p>	<p><b>MALAYSIA.</b></p> <p><b>OptoCom Equiptech (M) Sdn</b> H-49-2, Jalan 5, Cosmoplex Industrial Park. Bandar Baru Salak Tinggi, Sepang Tel: 603-8706 6806 Fax: 6038706 6809 <a href="mailto:optocom@tm.net.my">optocom@tm.net.my</a> <a href="http://www.optocom.com.my">www.optocom.com.my</a></p>	<p><b>PORTUGAL.</b></p> <p><b>UltraSens.</b> Tel.: (0351) 239700373 Fax: (0351) 239700301 <a href="http://www.ultrasens.com">http://www.ultrasens.com</a> <a href="mailto:geral@ultrasens.com">geral@ultrasens.com</a></p>
<p><b>RUSSIA.</b></p> <p><b>Sensorika-M LLC</b> Dmitrovskoye shosse 64, k.4 127474, Moscow, Russia Tel.: 487-0363 Fax: 487-7460 <a href="http://www.sensorika.com">http://www.sensorika.com</a> <a href="mailto:info@sensorika.com">info@sensorika.com</a></p>	<p><b>SOUTH KOREA.</b></p> <p><b>Santec Co</b> 322, Wongok-dong Danwon-gu Ansan-si Kyunggi-do, 425-850 Tel : +82-31-493-1162 Fax: +82-31-493-1164 <a href="http://www.santec.co.kr">http://www.santec.co.kr</a> <a href="mailto:mailto:santec@naver.com">mailto:santec@naver.com</a></p>	<p><b>SPAIN</b></p> <p><b>Iberfluid Instruments</b> C/ Cardenal Reig, 12 08028 BARCELONA Tel. 93 447 10 65 Fax. 93 334 05 24 <a href="mailto:myct@iberfluid.com">myct@iberfluid.com</a> <a href="http://www.iberfluid.com">http://www.iberfluid.com</a></p>
<p><b>SWITZERLAND</b></p> <p><b>ID&amp;T GmbH</b> Gewerbestrasse 12/a 8132 Egg (Zurich) Tel.: +41 (0)44 994 92 32 Fax: +41 (0)44 994 92 34 <a href="http://www.idtlaser.com">www.idtlaser.com</a> <a href="mailto:info@idtlaser.com">info@idtlaser.com</a></p>	<p><b>TURKEY.</b></p> <p><b>Mates A.S.</b> Gezegen Sok. N: 10 GOP ANKARA/TURKEY Tel.: +90 312 447 2192 Fax : +90 312 447 2193 <a href="http://www.mates.com.tr">www.mates.com.tr</a> <a href="mailto:mates@mates.com.tr">mates@mates.com.tr</a></p>	<p><b>UKRAINE.</b></p> <p><b>KODA</b> Frunze st 22, 61002, Harkov, Ukraine Tel/fax.: +38 057 714 26 54 <a href="http://www.koda.com.ua">http://www.koda.com.ua</a> <a href="mailto:mail@koda.com.ua">mail@koda.com.ua</a></p>
<p><b>United Kingdom, Ireland</b></p> <p><b>Ixthus Instrumentation</b> The Stables, Williams' Barns Tiffield road, Towcester, Northants, UK Tel.: 01327 353437 Fax: 01327 353564 <a href="http://www.ixthus.co.uk">www.ixthus.co.uk</a> <a href="mailto:info@ixthus.co.uk">info@ixthus.co.uk</a></p>	<p><b>USA, CANADA</b></p> <p><b>IEM Corporation</b> 850 River Street, Troy NY 12180-1239, USA Tel.: 518.268.1636 Fax: 518.268.1639 <a href="http://www.iem.net">www.iem.net</a> <a href="mailto:jskaggs@iem.net">jskaggs@iem.net</a></p>	